

PHILIPS-SERVICE

625U

16,7—51 m
186—585 m
708—2000 m

9646 Z = 5 Ω

110, 125, 200, 220 V 25—40W

473 kc/s

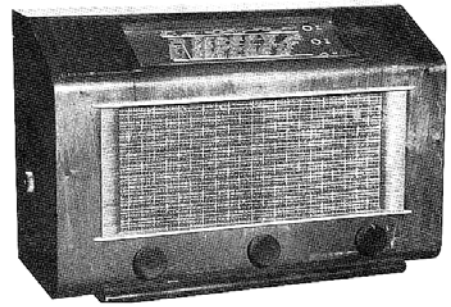

186—585 m I	186—585 m II	186—585 m V
VOL max	VOL max	859 kc/s—Y
C6, C7 () 200 m	C6, C7 + 15°	C6, C7 () max
473kc/s-33000 pF-g1B2	1550 kc/s—Y	↑ 350 m
82pF—S52	C38, C14 max	
82 pF—S61/S62		
S51, S63/S64-max		
S52		
S61/S62		
82pF—S51		
82pF—S63/S64		
S52, S61/S62—max		
S51		
S63/S64		



1942/43

R1	1K2	C1	55u
R31	100K	C2	25u
R33	470K	C20	4p7
R34	22K	C34	22p
R35	18K	C35	1000p
R36	82	C44	18p
R37	1M5		
R38	56K	C72	47000p
R39	47K	C73	47000p
R41	1M	C75	32u
R43	5K6	C84	22000p
R44	2K7	C100	1000p
R45	100K	C101	47000p
R46a	390	C103	100p
R46b	330	C104	150p
R50	100	C105	430p
R61	330	C106	470p
R62	175	C108	47000p
R63	120	C109	47000p
R64	500	C110	4700p
R65	100K	C112	100000p
R66	68		
R72	150	C120	100000p
R73	330		
R81	47K	C132	22000p
R100	100		

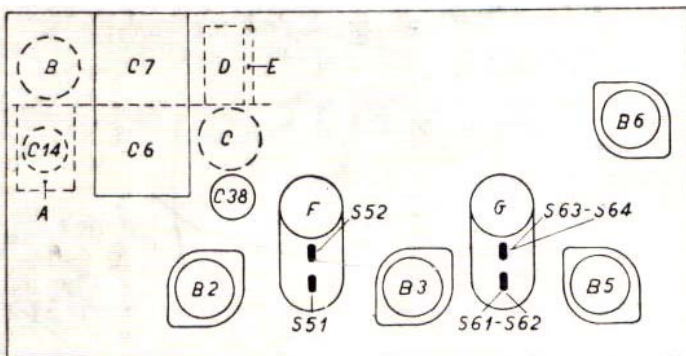

	B2	B3	B5	B6	
	UCH4	UF9	UBL1	UY1	
Va	aT 80 aH 170	170	190		V
Vg2	85	84	170		V
Vk	1,5	1,9	13		V
Ia	aT 2,6 aH 4,5	3,5	36		mA
Ig2	4	1,2	4,9		mA

VC1=210 V VC2=170 V

L1, L2 = 8089D

S 13 14 15 16 17 18 19 20 21 22 23 24 25 26 27 28 29 30 31 32 33 34 35 36 37 38 39 40 41 42 43 44 45 46 47 48 49 50 51 52 53 54 55 56 57 58 59 60 61 62 63 64 65 66 67 68 69 70 71 72 73 74 75 76 77 78 79 80 81 82 83 84 85 86 87 88 89 90 91 92 93 94 95 96 97 98 99 100

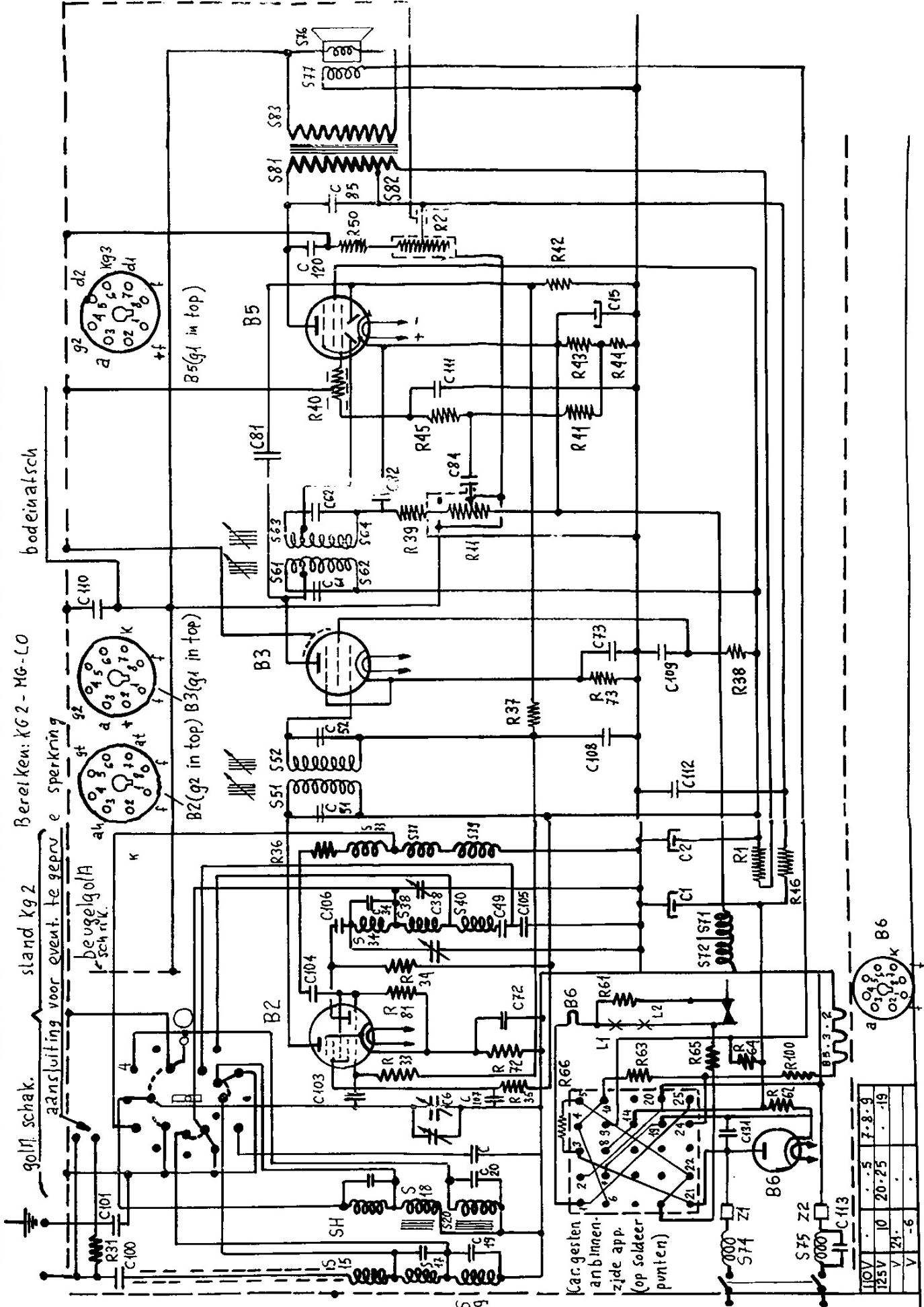

golfl. schak. aansluiting voor event. tegepr. e. sparkring
 stand kg 2 bereik: KG 2 - MG - LO
 beugelgolfl. a. k. sch. r. k.

bodeinaatsch

Car. gesten an binnen-zide app. (op solder punten)

SCHAA	ONTVANGER 43/44	625U-EVA
SCALE	PRINCIPESCHEMA	L A. DAT.
		SN
		ED
		-D AWN Oomen
		VERV. REMPL.
		SUPER
	PHILIPS GLOEILAMPEN	EINDHOVEN HOLLAND

110V	5	7.8.9
125V	10	20.25
V	24	.19
V	-6	

215
 202
 106
 206
 214
 270
 210
 292
 25
 30
 10X

34, 20, 71, 72, 73, 37, 39, 51, 52, 61, 62, 63, 64, 81, 82, 83, 77, 76
 72, 104, 74, 3, 381, 382, 2, 112, 51, 108, 52, 73, 105, 61, 100, 62, 1, 22, 11, 81, 11, 75, 120, 85
 72, 62, 36, 33, 66, 63, 65, 69, 61, 81, 34, 1, 46, 37, 79, 38, 45, 40, 41, 43, 44, 42, 50, 21

Bereik: K62 - HG - Ld
 stand KQ2
 aansluiting voor event. te gebruiken sperkring
 beugel golf.
 schak.

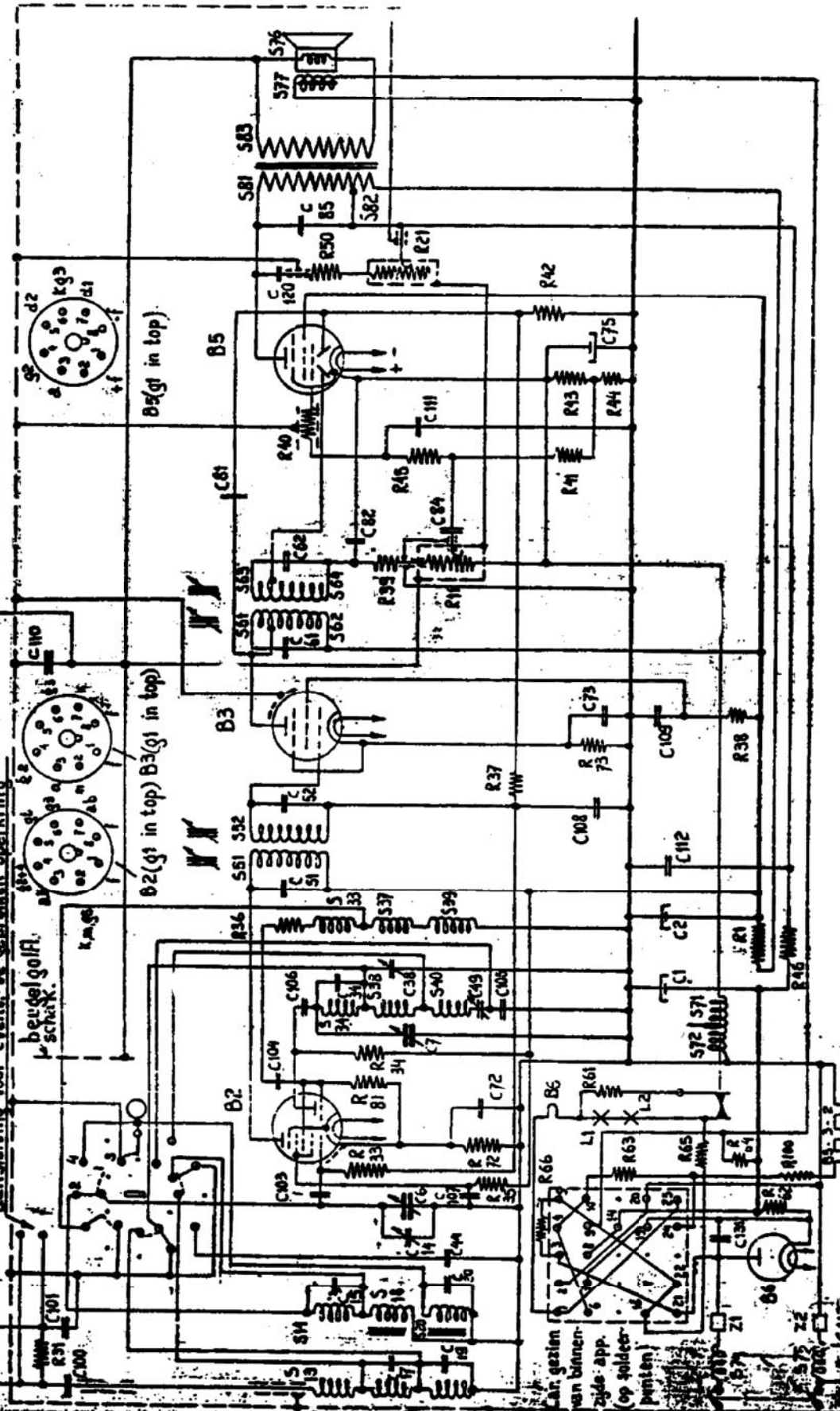

10V	12	15	20	25	30	35	40	45	50
10V	12	15	20	25	30	35	40	45	50

NICHIAAL MASSI SCHEMELLE SCALE	ONTVANGER 43/44	625 U - EVA
PRINCIPESCHER	DATE: 22-42	ONMEN
GELEIDERS GEZ-DRAWN VERV-REPL. RES-SUPERS	PHILIPS' GLOEILAMPEN EN VELEN TE EINDHOVEN - HOLLAND.	

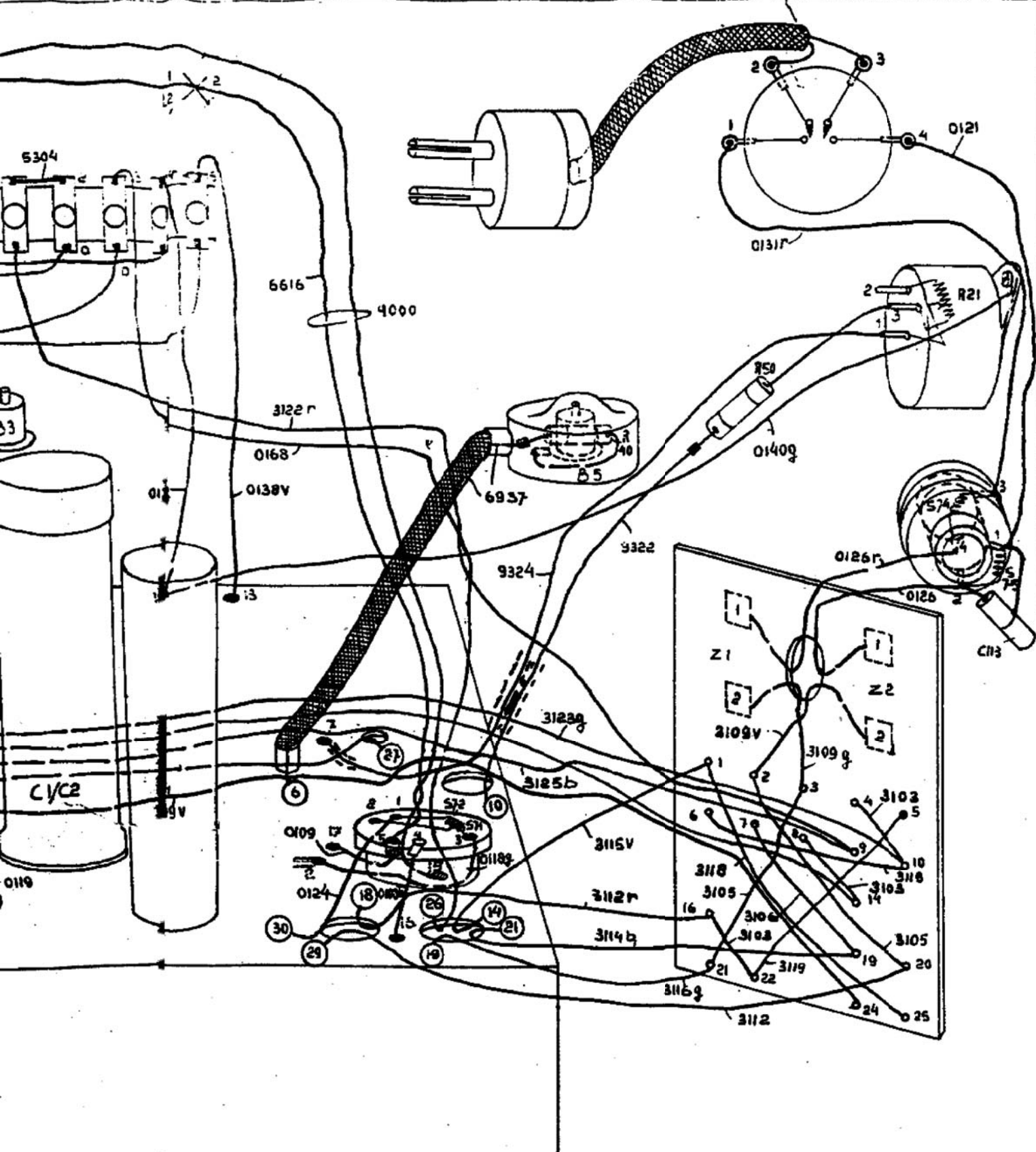

IND.-TRAIT.
TMENT

SCHAAL
MÄSSY
SCHELLE
SCALE

EGENH.-BINN.
UNITS-UNIT
SCALE

ONTVANGER 43/44

OPSTELLINGS-ËN MONTAGE SCHEMA
(bovenaanzicht)

625U-EVA

BL. P.-SH 24 A G. DAT. 16-7-42

GET-DESS. BEZ-DRAWN Felten

VERV-REMP. PERS-SUPERS

8-9-42

27-4-43

8-9-43

N.V. PHILIPS' GLOEILAMPENFABRIEKEN TE EINDHOVEN - HOLLAND.

HERBIJ GEBRUIKEN - A UTILISER AVEC
ZU VERVOLGEN MIT - FOR USE WITH

GEDEELT. VOOR - EN PARTIE POUR
TELWEESE FÜR - PARTLY TO

BELOOT OOK GEHEVEL VOOR - RENT AUSSI EN FILLER POUR
EËN AUCH GANZ FÜR - APPLIES ALSO TO WHOLE OF

FORM
TIP
FILL

103	108	107	104	106	38	44	72	34	101	115	20	49	100	17	19	14
33	1	34	35	30	31	72					31					

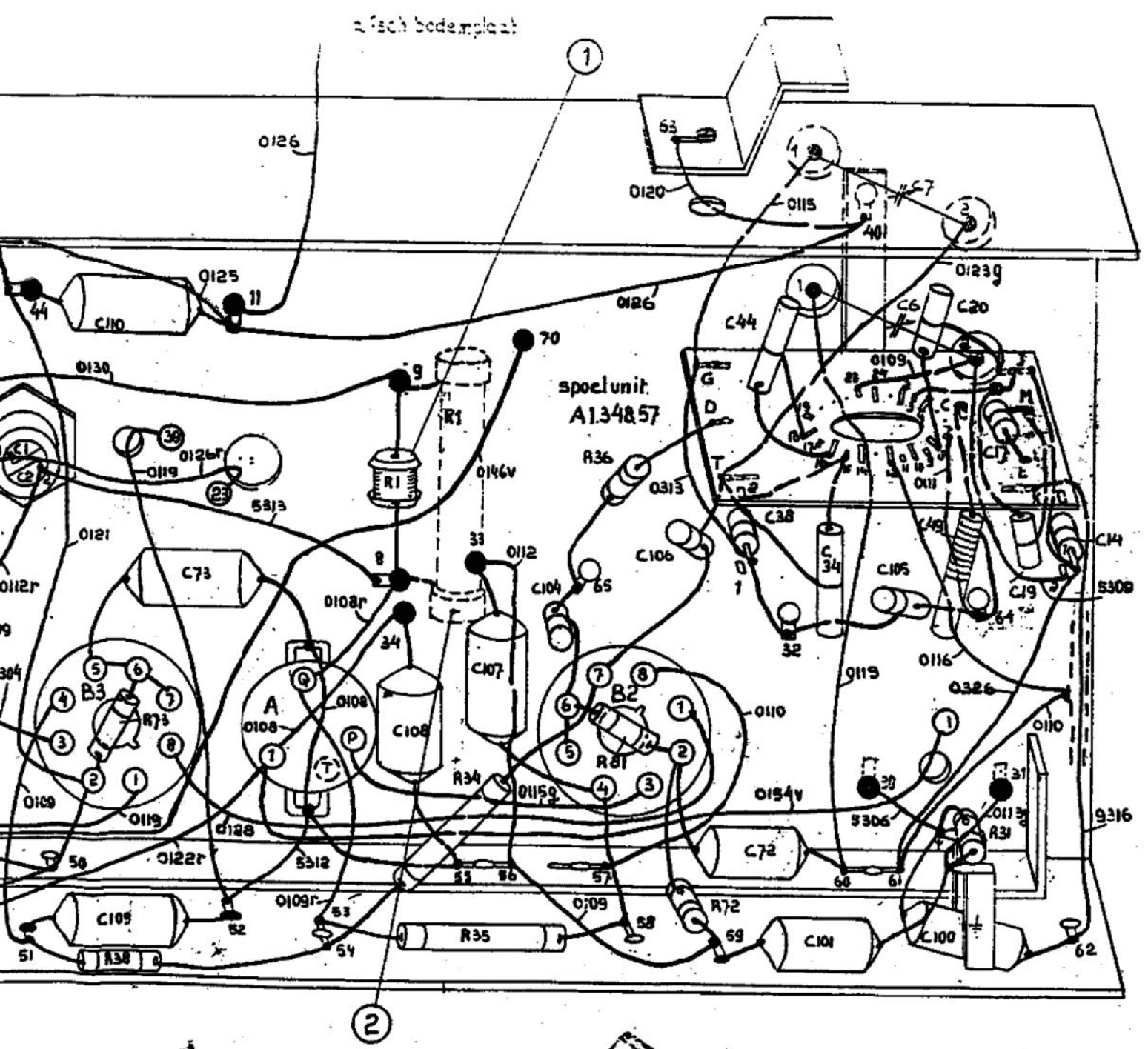

BEKEND-TRAIT. TAKTMEET	SCHAAL MASST SCHELLE SCALE
TECHN. FINN UNITE-UNIT	

ONTVANGER 43/44
MONTAGESHEMA

625U-EVA		8-9-42
BY SH 231	BY 16-7-42	27-4-43
DES. Fellen		16-9-43
TECH. DRAWN		
REV. REWPL		

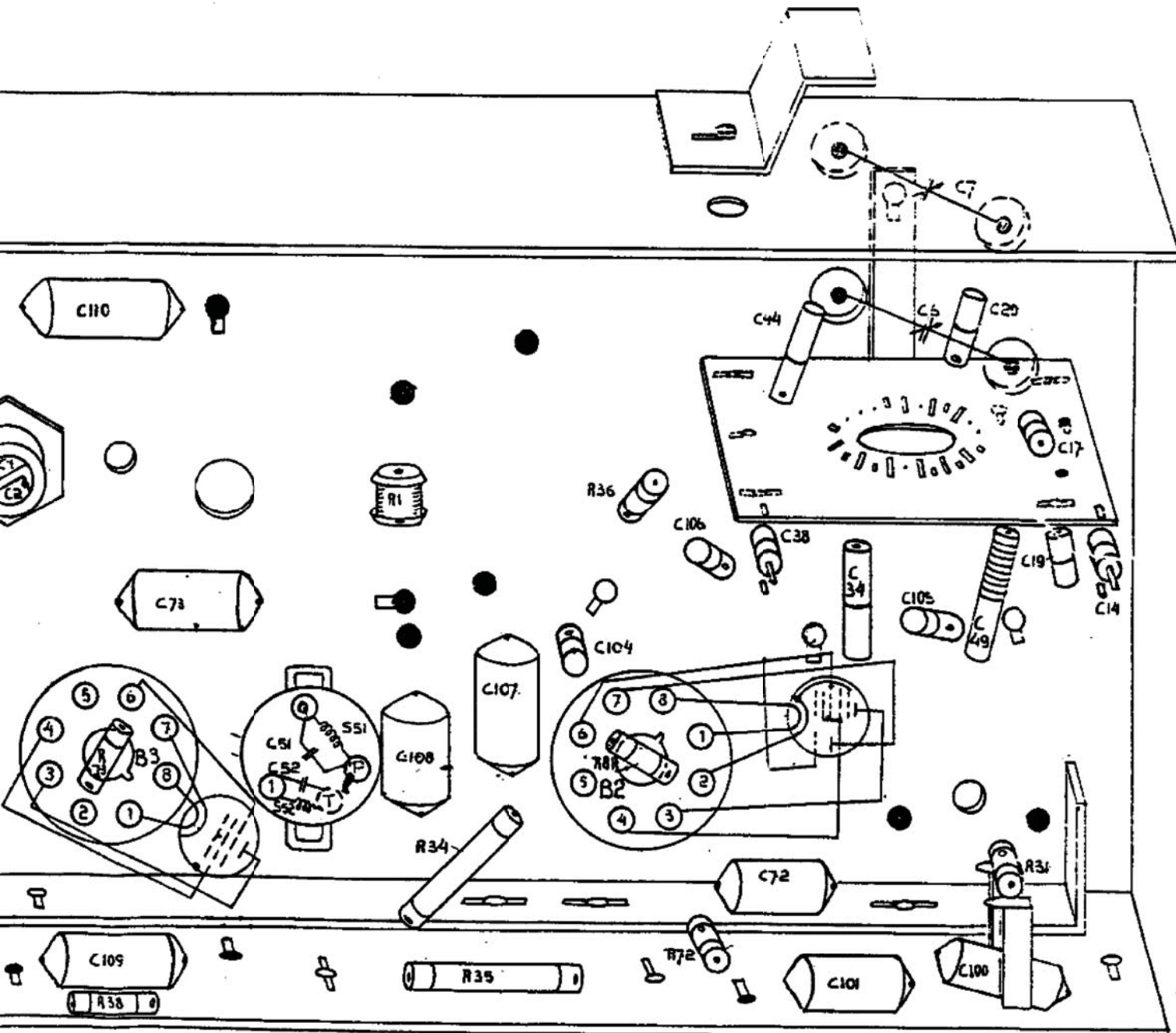

BEHAND.-TRAIT. TREATMENT		ONTVANGER 43/44		625U-EVA		8
MAT.		SCHAAL MÄSST EHELLE SCALE		P.-SH. 22		16-7-42
BEWERKING GEARBEIDING USINAGE & OPERATION		EENH.-EINH. UNITS-UNIT MM		GET.-DESS. GEZ.-DRAWN VERS.-REMP. ERS.-SUPERS		Felten.
N.V. PHILIPS GLOBOLEN EN FABRIEKEN TE EINDHOVEN - HOLLAND						

625U-EVA-19
 GEDEELT VOOR - EN PARTIE POUR
 625U-EVA-19